

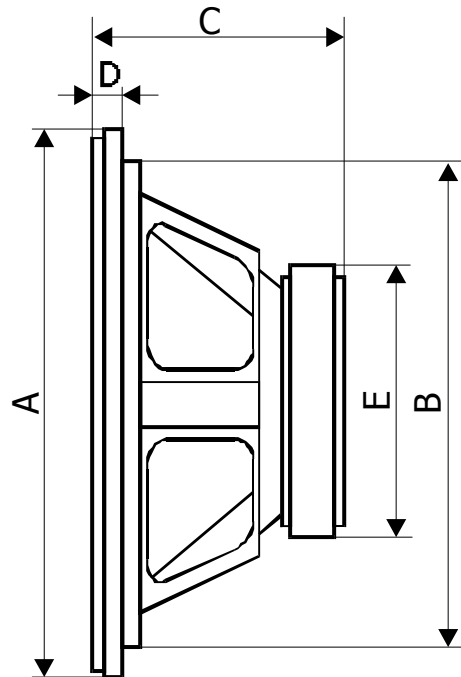

SR 2010



A	Külső átmérő Diameter Durchmesser	205 mm
B	Beépítési átmérő Mounting cutout Einbauöffnung	184 mm
C	Beépítési mélység Mounting depth Einbautiefe	84 mm
D	Perem vastagság Edge width Randstreifen	8 mm
E	Mágnes átmérő Magnet diameter Magnetdurchmesser	80 mm